



# CORE HEALTH & FITNESS

8-TRx/8-TR Treadmills

**OWNER'S  
MANUAL**



<b>IMPORTANT SAFETY INSTRUCTIONS</b> .....	<b>2</b>
<b>IMPORTANT LABEL LOCATIONS</b> .....	<b>4</b>
<b>PRODUCT SPECIFICATIONS</b> .....	<b>6</b>
<b>PART IDENTIFICATION</b> .....	<b>7</b>
<b>OPERATION - OPENHUB LCD CONSOLES</b> .....	<b>8</b>
<b>OPERATION - OPENHUB TOUCHSCREEN CONSOLES</b> .....	<b>13</b>
<b>SCREEN VIEWS</b> .....	<b>16</b>
<b>WORKOUT SELECTION KEYS AND PROGRAM DEFINITIONS</b> .....	<b>18</b>
<b>PROGRAM UPLOAD</b> .....	<b>19</b>
<b>MENU MAP - TREADMILL</b> .....	<b>21</b>
<b>MAINTENANCE MODE</b> .....	<b>22</b>
<b>CALIBRATION - OPENHUB LCD</b> .....	<b>24</b>
<b>CALIBRATION - OPENHUB TOUCHSCREEN</b> .....	<b>25</b>
<b>MAINTENANCE</b> .....	<b>27</b>
<b>TOOLS</b> .....	<b>27</b>
<b>MAINTENANCE SCHEDULE</b> .....	<b>28</b>
<b>SUPPORT &amp; SERVICE</b> .....	<b>30</b>

## WARNING!



Before using this product, it is essential to read the ENTIRE Owner's Manual and ALL installation instructions. The Owner's Manual describes equipment setup and instructs members on how to use correctly and safely.

Read all warnings posted on the machine.



Health related injuries may result from incorrect or excessive use of exercise equipment. Core Health & Fitness strongly recommends you to encourage your members to discuss their health program or fitness regimen with a health care professional, especially if you or they have not exercised for several years, are over 35, or have known health conditions.

### **DANGER - to reduce the risk of electrical shock:**

1. Always unplug the machine from the electrical outlet before cleaning or servicing.
2. This machine is not intended to be serviced by the end user, refer servicing to qualified personnel only.
3. This machine is designed for aerobic exercise in a gymnasium or health club environment (FOR COMMERCIAL USE). It is wired for either 110 VAC 20A OR 230 VAC 15A nominal power input. It is factory-equipped with a specific electric cord and plug to permit connection to the proper electric circuit. Make sure that the treadmill is connected to a dedicated power line having an outlet with the same configuration as that of the plug:
  - 20A for 110V models
  - 15A for the 230V models
4. If the power supply cord is damaged, it must be replaced by the manufacturer, its service agent, or similarly qualified persons in order to avoid hazard.
5. Do not operate machine in damp or wet locations.

### **WARNING - to reduce the risk of injury to person:**

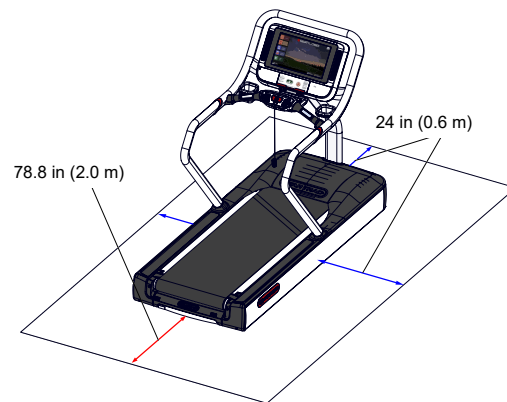



Fig. 1 Required Clearance

1. Assemble and operate the machine on a solid level surface. Position the machine with a minimum of 23.6 inches (0.6 meters) of clearance on each side to allow for ease of mounting and dismounting. Allow for 78.8 inches (2.0 meters) of clearance behind the machine. Leave a minimum of 19.7 inches (0.5 meters) between two adjacent units. These dimensions are the recommended minimum distances.

The actual area for access and passage shall be the responsibility of the facility and should take into account this training envelope, Americans with Disabilities Act Accessibility Guidelines (ADAAG) requirements and any required local codes or regulations ([www.access-board.gov/ada](http://www.access-board.gov/ada)).

2. Do not exceed the maximum allowable weight limit of:
  - 8-TRx - 500 lbs. / 227 kg.
  - 8-TR - 500 lbs. / 227 kg.
3. Familiarize yourself with the location of the STOP buttons on the console. If you experience difficulties during the workout, pushing the STOP button will bring the machine to a stop.
4. Lock your treadmill when not in use. Use the Lockout EN option in MAINTENANCE MODE to enable or disable treadmill lockout. When the treadmill is locked, the display shows the message "TREADMILL LOCKED, PRESS 0 TO ENTER ID". The user must press "0", enter the 3-digit ID number (default=999), then press ENTER to unlock the treadmill. The treadmill will then operate as normal (NOTE: The treadmill will lock back up if it is idle for 30 seconds).
5. Use care when getting on or off the treadmill. Always use the handrails. Do not step off of the treadmill while it is moving. Press the STOP button and wait for the treadmill to come to a complete stop before dismounting.
6. Inspect the treadmill for incorrect, worn, or loose components and then correct, replace, or tighten prior to use.
7. Obtain a medical exam before beginning any exercise program. If at any time during exercise you feel faint, dizzy, or experience pain, stop and consult your physician.
8. Keep children away.
9. Do not wear loose or dangling clothing while using the treadmill.
10. Do not operate the machine if the motor shroud is removed or if the power cord is damaged in any manner. Keep all air openings free from dirt or any material that would block the flow of air to the motor.
11. Keep the top side of the moving surface clean and dry.
12. The safety and integrity of this machine can only be maintained when the equipment is regularly examined for damage and wear and repaired. It is the sole responsibility of the owner of this equipment to ensure that regular maintenance is performed. Worn or damaged parts must be replaced immediately or the equipment removed from service until the repair is made.
13.  **WARNING:** Heart rate monitoring systems may be inaccurate. Over-exercising may result in serious injury or death. If you feel faint stop exercising immediately.
14. Noise emission under load is higher than without load.

### SAVE THESE INSTRUCTIONS

# IMPORTANT LABEL LOCATIONS



This page shows examples of the warning labels and communication stickers placed on the equipment as part of the manufacturing process. It is critical that owners maintain the integrity and placement of these stickers. If you find any stickers missing or damaged the replacement numbers are shown on the support site. See Support and Service to order replacements. For console warnings, refer to console documentation for part replacement. NOTE: STICKERS AND LABELS ARE NOT SHOWN TO SCALE

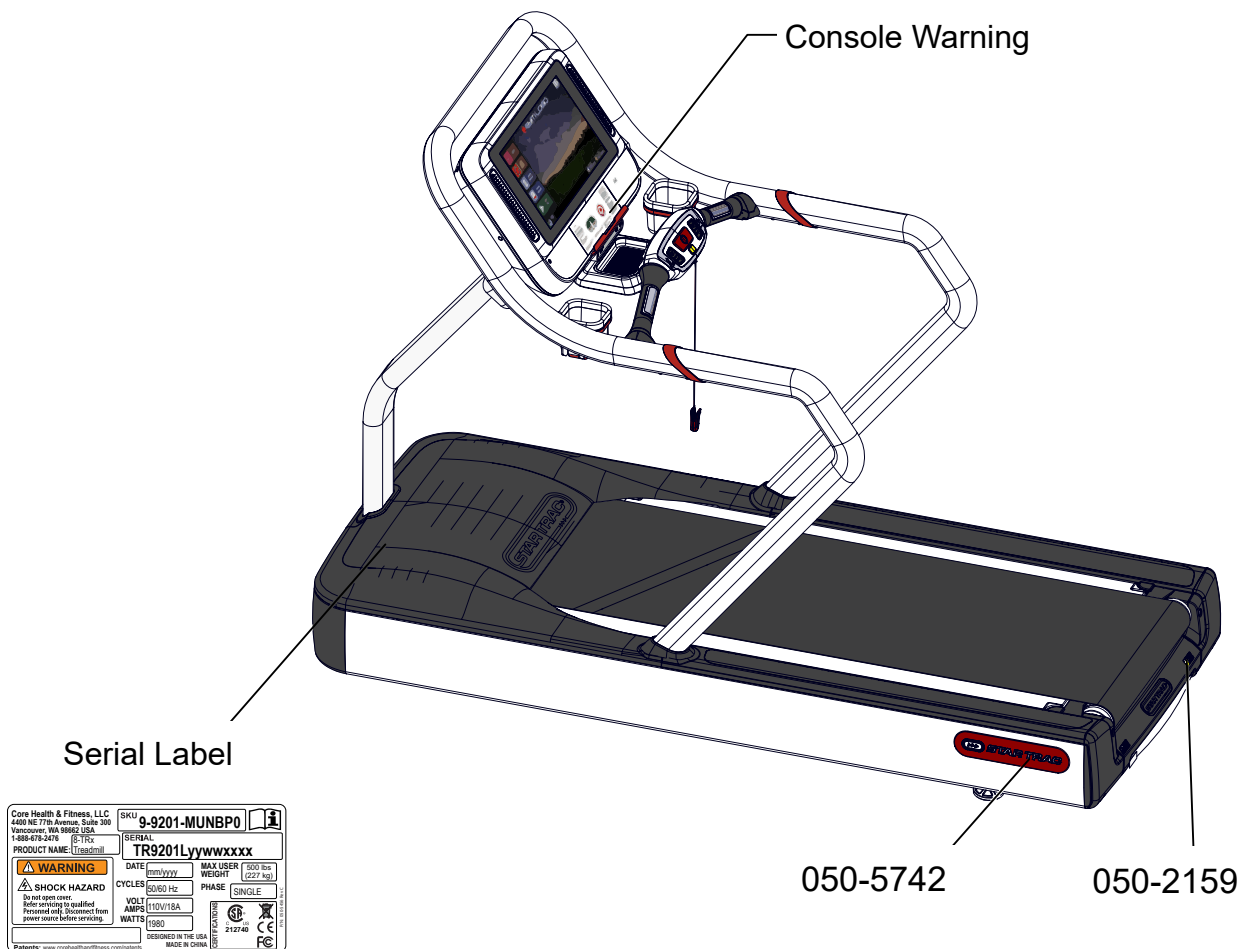

Fig. 2 Pictured with 19" OpenHub Embedded Console



**050-2159**

LABEL, CAUTION, PINCH POINTS, TR



**050-5742**

LOGO, STAR TRAC, EMBOSSED



Fig. 3 Pictured with 19" OpenHub Embedded Console

**SKU:** 9-9291 110V  
9-9294 220V CE/UL/FCC/CSA

**Desc:** 8-TRx Treadmill

Unit Weight		Width		Length		Height		Belt Width		Max User Weight
<b>471</b>	lbs	<b>32</b>	in	<b>81</b>	in	<b>60</b>	in	<b>22</b>	in	<b>0-500</b> lbs
<b>214</b>	kg	<b>81</b>	cm	<b>209</b>	cm	<b>150</b>	cm	<b>55</b>	cm	<b>0-226</b> kg

**SKU:** 9-9191 110V  
9-9192 220V, UL/FCC  
9-9194 220V, CE

**Desc:** 8-TR Treadmill

Unit Weight		Width		Length		Height		Belt Width		Max User Weight
<b>576</b>	lbs	<b>36</b>	in	<b>85</b>	in	<b>63</b>	in	<b>22</b>	in	<b>0-500</b> lbs
<b>261</b>	kg	<b>91</b>	cm	<b>216</b>	cm	<b>160</b>	cm	<b>55</b>	cm	<b>0-226</b> kg

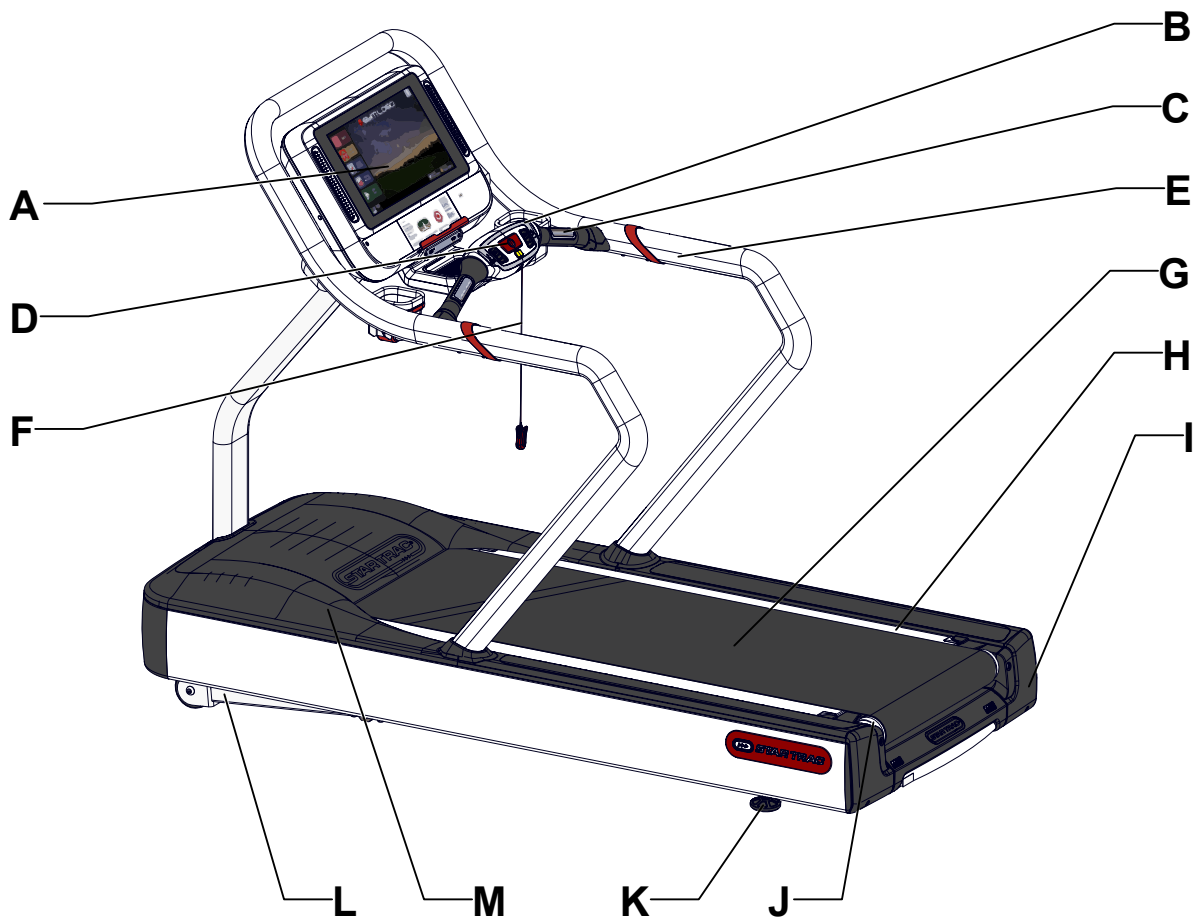

Fig. 4 8-TRx Features pictured with 19" OpenHub Embedded Console

#	Part	#	Part	#	Part
A	Console	F	Safety Stop (Cord)	K	Foot
B	Front Handlebar	G	Moving Surface	L	Elevation Frame
C	Heart Rate Grips	H	Deck	M	Motor Shroud
D	Safety Stop (Button)	I	Rear Roller Shroud		
E	Handrail	J	Rear Roller		



# OPERATION - OPENHUB LCD CONSOLES

## SAFETY FIRST

Your treadmill is equipped with an easy to reach HOT BAR® that provides you with an additional PAUSE/STOP button and a Stop Switch.

The Stop Lanyard Clip attached to the HOT BAR® is provided for your protection to stop the machine.

**Always attach the Stop Lanyard Clip to your clothing before each workout.**

Attach it to your clothes near the waistline. If the cord is pulled the Stop Switch will be activated and the treadmill will stop operating.

If the Stop Switch has been activated, press the smaller yellow RESET button to reset the treadmill and resume normal operation.

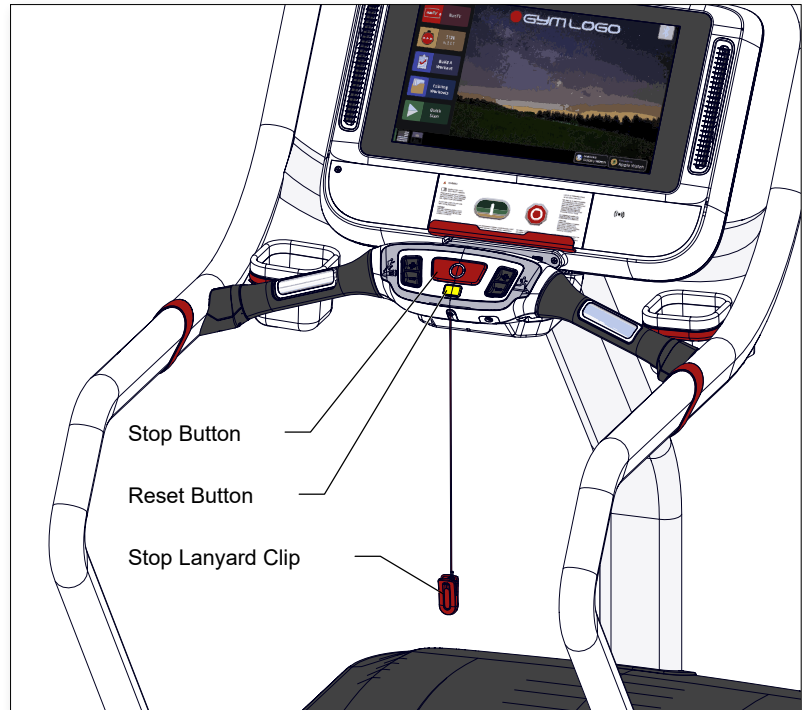

Fig. 5

During use, press the red STOP button to PAUSE your workout. Press the STOP button a second time while in Pause mode to stop and cancel the workout program.

**Important:** Facility owners, managers, personal trainers and personnel. Remind users of the importance of using the Stop Lanyard Clip. It is the facility's responsibility to train and instruct the proper use of this treadmill, including the safety features.

**Note:** A clipping feature is provided in the display housing to store the Stop Lanyard Clip when the treadmill is not in use.

## SAVE THESE INSTRUCTIONS

## DISPLAY MEASUREMENTS



### SPEED

Displays the current speed in MPH/KPH



### INCLINE

Displays the current incline as percent grade



### KCAL

Displays accumulated calories burned



### WATTS/METS

Alternates display of current user Watts and METS

**WORKOUT PROFILE** Displays profile of past and upcoming speed levels relative to one another

**SEGMENT TIMER** Below the Workout Profile area is a segment timer that counts down the time remaining in the current segment.

## TOP DISPLAY WINDOW

The top display window includes several measures:

<b>TIME</b>	Current total workout time
<b>HEART RATE</b>	Current HR in beats per minute, if available
<b>PACE</b>	Current pace in minutes/mile or km
<b>LAPS COMPLETED</b>	Total no of laps completed
<b>VERTICAL DISTANCE</b>	Total distance climbed in feet or meters distance

## CONSOLE KEY FUNCTIONS



### QUICK START Key

Enables manual operation using a default weight, SPEED and a default time limit.  
NOTE: Default time and weight are adjustable through Maintenance Mode.



### Fan Button

Cycles the fan between three settings: High, Low and Off

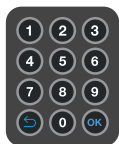

### Numeric Keypad

Use to enter specific values for program parameters during program setup. During a program, these keys may be used to change level.



### Up/Down Buttons

Cycle between options during setup mode, adjust incline & speed up and down during workout mode

## BLUETOOTH DEVICE PAIRING

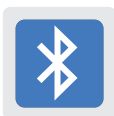

**Bluetooth Device Pairing with Bluetooth Button:** Pushing the button puts the console into discover mode. The console will be available for pairing for up to 60 seconds to pair with a compatible App. The button will flash while searching for pairing, and the display will show the unique console code. Once a device is paired with the console, the light will stop flashing and remain on to indicate the connection. Visit our website for a list of compatible Apps.



**Pairing with Apple Watch:** OpenHub consoles marked with this icon (📶) have the capability to connect using Near Field Communication (NFC) with Apple Watch (must be running WatchOS 4.2 or later and have option **Detect Gym Equipment** set to **On** in Watch settings for Workout App.)



**Pairing with Samsung Galaxy Watch:** OpenHub consoles marked with the Samsung icon also have the capability to connect with Samsung Galaxy Watch (must be running software 4.8 or later and have **NFC** set to **On**)<sup>1</sup>.

**To connect:** Hold the watch near the (📶) icon on the console (this is where the NFC reader is located). When the display and watch detect each other, the Bluetooth button on the display will flash and then turn solid blue, and watch will ask user to confirm connection with the display. Once connection is confirmed by user, it will finalize and data will begin to pass between console and watch. It is possible to make this connection either before the workout begins (recommended), or at any time during an active workout. At the end of workout, the connection will be terminated.

**Note:** when Apple Watch is connected to display, the Calories display window will show both Active and Total Calories per Apple Watch calculations.

<sup>1</sup> See [support.corehandf.com/Software](http://support.corehandf.com/Software) for version numbers and update instructions

## WORKOUT SELECTION KEYS AND PROGRAM DEFINITIONS



### Manual

Similar to Quick Start, but allows user to enter a time goal and weight for more accurate calorie measurement



### 5k Loop

Similar to Quick Start, but is a pre-set distance



### Fitness Tests

Provides access to sub-menu to select from one of 7 different fitness test programs:

#### 1. Fitness Test

The Fitness Test is a modified version of the Balke and Ware protocol for maximal VO<sub>2</sub> treadmill testing. The original Balke-Ware protocol is a 20 minute test with a maximum elevation of 20%, the test has been modified to last 12 minutes with a maximum incline of 12%. This protocol is appropriate for all users but mostly used for older, deconditioned, or patient groups. During the Fitness Test, treadmill speed remains at a constant 3.4 mph. Treadmill incline is set at 0% during the first minute, increases to 2% during the second minute, and increases by 1% per minute for the remainder of the test. During the test you MAY NOT adjust the treadmill speed or incline, and you MAY NOT pause the program. If your heart rate exceeds 150 BPM for more than one minute, the test will terminate automatically. Your heart rate results are compared with charted data for your corresponding age and gender. Test results include your calculated VO<sub>2</sub> max. VO<sub>2</sub> max is a physiological measurement of a body's ability to absorb oxygen and has specific correlation to your fitness level. See "Calculation for VO<sub>2</sub> Max" for more information

#### 2. Firefighter Test

The Firefighter test found in the Star Trac 8 Series Treadmill is based on the Gerkin Protocol developed by Dr. Richard Gerkin of the Phoenix (Arizona) Fire Department. It is a sub-maximal graded treadmill evaluation used by many Fire Departments across the United States to assess the condition of the firefighters. The program operates as follows:

- Warm-Up** During warm-up, the treadmill runs at 3.0 mph (4.8 kph), 0% incline for 3 minutes.
- Stage 1** At 3 minutes, treadmill speed increases gradually to 4.5 mph (7.2 kph). The test begins at 4.5 mph (7.2 kph). During the test, heart rate is continuously monitored.
- Stage 2** After one minute, treadmill incline increases to 2%.
- Stage 3** After one minute, treadmill speed increases to 5.0 mph (8.0 kph).
- Stages 4 through 11** After every odd minute, treadmill incline increases an additional 2%. After every even minute, treadmill speed increases by 0.5 mph (0.8 kph). Once the

user's heart rate exceeds the target HR (85% of maximum), the individual continues the evaluation for an additional 15 seconds. During this 15 second period, the evaluation remains at the stage where the target HR is exceeded, with speed or grade unchanged. If the HR does not return to or below the target HR, the evaluation ends and the final evaluation stage is recorded. If the HR returns to or below the target HR, the program continues at the point where it would have been had the program not stabilized for 15 seconds.

### Test

**Completion:** The test is completed when user heart rate exceeds target for more than 15 seconds or the user completes all 11 stages, whichever occurs first. The treadmill will enter a Cooldown cycle for 3 minutes at 3.0 mph (4.8 kph), 0% incline.

**NOTE:** You must wear the heart rate strap during the Firefighter Test to monitor your heart rate.

3. USMC 3 Mile Run - Object is to complete as quickly as possible
4. US Army 2 Mile Run - Object is to complete as quickly as possible (HR strap required)
5. US Navy 1.5 Mile Run - Object is to complete as quickly as possible
6. USAF 1.5 Mile Run - Object is to complete as quickly as possible
7. 2.4KM Fitness Test - Object is to complete as quickly as possible



#### Random Hill

Climbing, interval-style workout 250 different terrain configurations to add variety



#### Alpine Pass

Climbing, interval-style workout with a progressive high level of intensity



#### Training Tools

Two HR Control training programs (HR strap required)

#### Dynamic

The Dynamic HR Control program is designed to gradually elevate your heart rate to the upper end of your selected training range, then gradually decrease your heart rate to the lower end of your selected training range using speed and incline. During the workout, this cycle will repeat several times, creating an interval training effect that is customized to the user's desired heart rate training range.

**NOTE:** During program setup, there must be at least an 18 BPM difference between the lower heart rate limit and upper heart rate limit to ensure an interval workout.

#### Constant

This heart rate feature is designed to maintain your heart rate at a constant level by varying the treadmill incline during your workout. Note that your heart rate may vary above and below your target heart rate during this program.

# OPERATION - OPENHUB TOUCHSCREEN CONSOLES



Fig. 6 Treadmill Hotbar

## CONSOLE & HOTBAR (WHERE APPLICABLE) FUNCTIONS

	<b>F</b> QUICK START Key	Enables manual operation using a default weight, SPEED and a default time limit. <b>NOTE:</b> Default time and weight are adjustable through Maintenance Mode.
	<b>G</b> STOP Button	Press the STOP button to enter pause mode. Workout will be suspended and a countdown timer will begin counting down from 2 minutes. To re-start workout press the  Key. To end the workout push the STOP button again
	<b>C</b> Flag Button	Displays language options, appears only on home screen
	<b>D</b> Unit Button	Unit toggle, appears only on home screen
	<b>I</b> Speed Adjustment	Allows user to increase/decrease speed



**H** **Incline Adjustment** Allows user to increase/decrease incline (Treadmill/Treadclimber Only)



**Level Adjustment** Allows user to increase/decrease program level (8G and 10G Only)

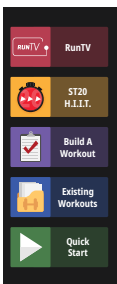

**A** **Main Menu** Workout controls, varies by unit. See the Menu Map for complete details.

## BLUETOOTH DEVICE PAIRING B



Pushing the button opens the bluetooth menu. After selecting the device type, the console will show all available local devices. The display will show the unique console code. Once a device is paired with the console, the light will stop flashing and remain on to indicate the connection. Visit [openhubconnect.com](https://openhubconnect.com) for a list of compatible apps and demonstration video.



Fig. 7



**Pairing with Apple Watch E:** OpenHub consoles marked with this icon have the capability to connect using Near Field Communication (NFC) with Apple Watch (must be running WatchOS 4.2 or later and have option **Detect Gym Equipment** set to **On** in Watch settings for Workout App.)



**Pairing with Samsung Galaxy Watch:** OpenHub consoles marked with the Samsung icon also have the capability to connect with Samsung Galaxy Watch (must be running software 4.8 or later and have **NFC** set to **On**)<sup>1</sup>.

**To connect:** Hold the watch near the icon on the console (this is where the NFC reader is located). When the display and watch detect each other, the Bluetooth button on the display will flash and then turn solid blue, and watch will ask user to confirm connection with the display. Once connection is confirmed by user, it will finalize and data will begin to pass between console and watch. It is possible to make this connection either before the workout begins (recommended), or at any time during an active workout. At the end of workout, the connection will be terminated.

**Note:** when Apple Watch is connected to display, the Calories display window will show both Active and Total Calories per Apple Watch calculations.

<sup>1</sup> See [support.corehandf.com/Software](https://support.corehandf.com/Software) for version numbers and update instructions



**SCREEN VIEWS**



Fig. 8 Screen Elements





During most workouts, users can select from multiple screen view options by tapping the icons **G** at the bottom of screen. Screens vary by unit, all screens are shown in the Service Manual.

- Simple Key workout stats in a large and easily readable format
- Progress Workout stats plus graphical representation of segments
- Quick Workout stats plus customizable buttons to select incline/speed with single button press
- Entertainment View video from connected TV feed, or HDMI streaming from personal device (networked product only) Select from a preset list of on-board Apps, including: YouTube, Facebook, Instagram, Twitter, Reddit, Pinterest, BBC, NPR (list subject to change at any time)
- Apps View



Fig. 9 Apps View

Other controls vary by unit:

	<b>A</b> Fan Button	Cycles the fan between three settings: <b>High, Low</b> and <b>Off</b>
	<b>C</b> Bluetooth	Button is grayed out if no device is connected to the console.
	<b>D</b> Adjustment Buttons	Allows user to increase/decrease speed, level or incline depending on unit.
	<b>E</b> Exit/Back	This button has the same function as pressing stop button on hot bar, puts display into the pause screen.
	<b>F</b> Wallpaper	Select to set the screen background.

## Display Measurements B

Measurements are displayed at top of screen during workout, tapping any of the measurement boxes allows user to select alternative measures to display and may include the following measurements:

<b>Calories</b>	Active/Total calories burned Note: When connected to Apple Watch only
<b>Time</b>	Current total workout time
<b>Pace</b>	Current pace
<b>Incline</b>	Current degree incline
<b>Cal/Hour</b>	Current rate of calorie burn
<b>METS</b>	Current user METS
<b>Speed</b>	Current speed
<b>Vehicle Distance</b>	Height traveled/climbed
<b>Calories</b>	Accumulated calories burned
<b>Watts</b>	Current user Watts
<b>Heart Rate</b>	Current HR in beats per minute, if available

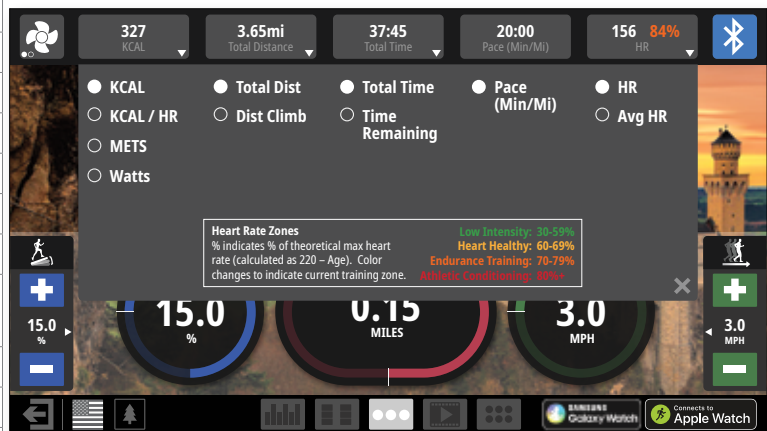

Fig. 10 Display Measurement Dropdown (Treadmill)

## WORKOUT SELECTION KEYS AND PROGRAM DEFINITIONS

On the main screen are several choices:

**Quick Start** Program will request user information to create more accurate calorie burn and heart rate zone calculations, then begin a fixed time (default length can be adjusted in maintenance mode) manual workout

### Existing Workouts

- 5K Time Trial
- Manual
- Random Hill
- Alpine Pass
- Evaluate Fitness (Fitness Test, Firefighter Test, Military Tests – see Service Manual for details)

### Build a Workout

- Custom Interval Training
- Heart Rate Training
- Time Goal
- Distance Goal
- Calorie Goal



Fig. 11 StarTrac Twenty

**Star Trac 20** A set of 5 different 20 minute High Intensity Interval Training (HIIT) program options, allowing users of all fitness levels to create a workout that allows them to experience the benefit of adding HIIT to their workout routine

**RunTV** A set of first person videos, allows users to choose from a variety of running paths to visually enhance their workout

## PROGRAM UPLOAD

Prior to starting a workout, a BlueTooth connected device can be used to upload a program to display on the console from a compatible app. The upload may contain user info such as age and weight.

1. In an App interface, select the option to Upload Program to Display and then select the program from the app to upload. Console will switch to shown page when responding to the app.

**NOTE:** if done while a workout is in progress, the display will not respond to the app command.



Fig. 12

2. The app will upload to the console. Pressing the cancel during this time will return to the home screen and remove any uploaded information from the console.



Fig. 13

- Once the program has loaded, press the green start button to progress to the setup screen.

**NOTE:** Console will return to home screen after 30 seconds or if cancel is pressed.

- If program fails to load, an error screen is displayed for 5 seconds before retuning to the home screen. Any error reporting is handled by the app, please check the app for additional details.



Fig. 14

- Information from the app may be adjusted on the setup screen, or press the GO button to begin the program.

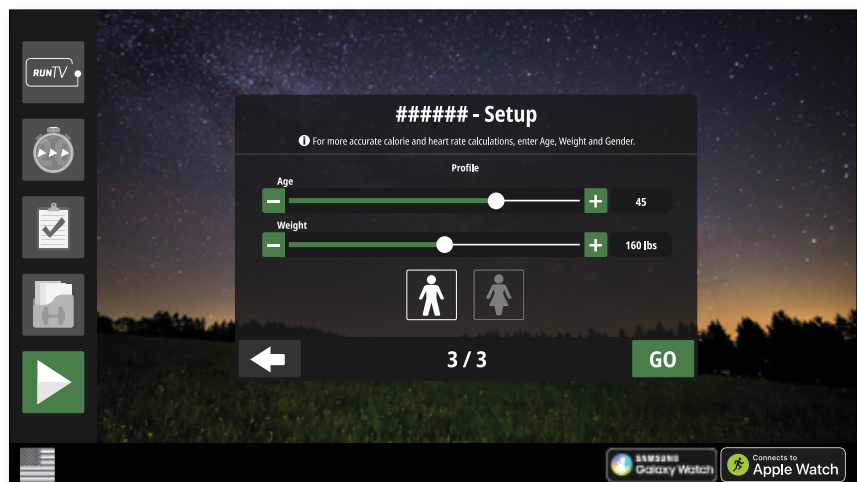

Fig. 15

**MENU MAP - TREADMILL**

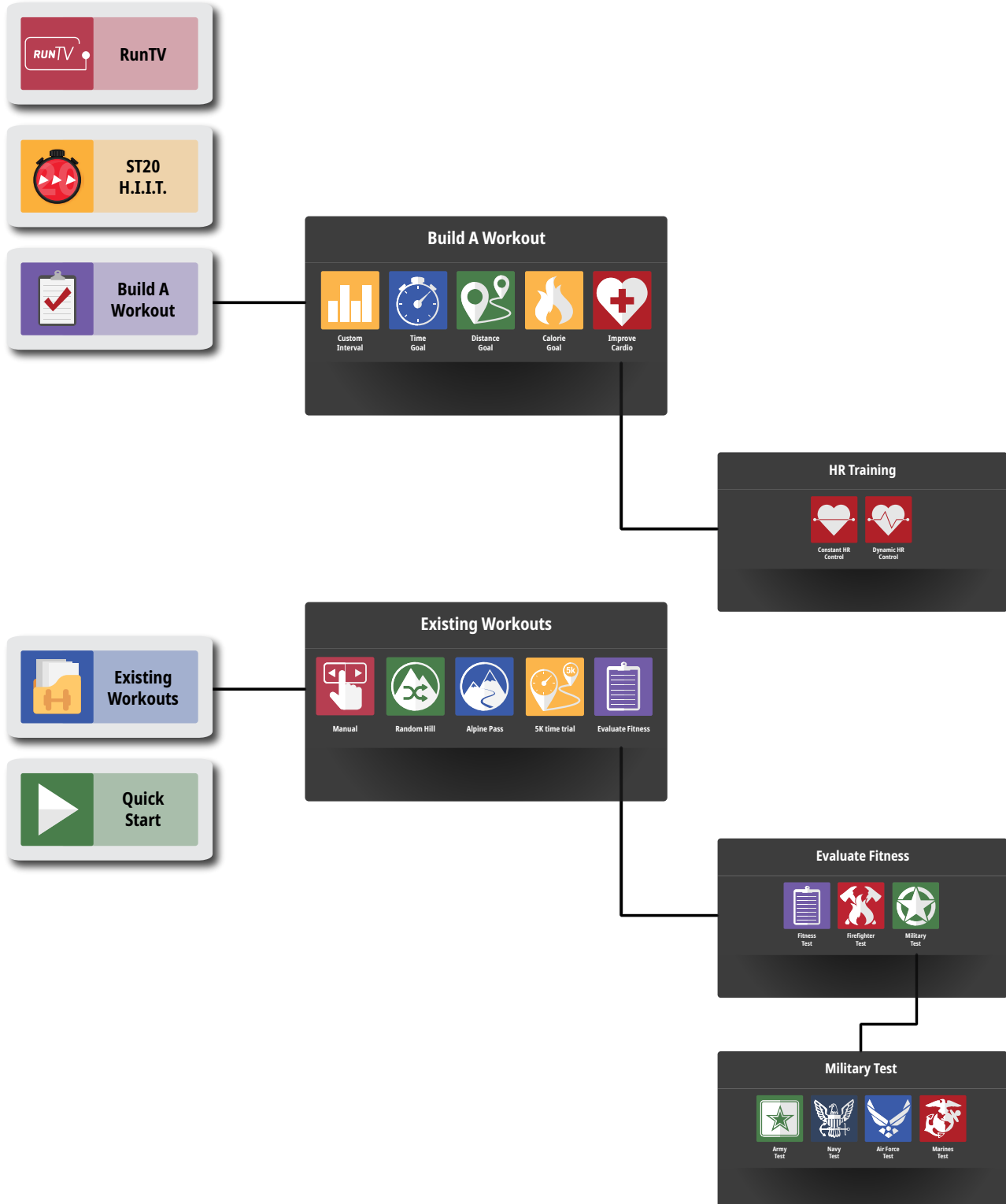

Fig. 16 Treadmill Menu Map

## LCD OPENHUB CONSOLE

Maintenance Mode allows access to service and diagnostic information, as well as provides the ability to adjust certain program default parameters. To enter Maintenance Mode:

1. Press and hold the **0**, **2** and **OK** keys together.
2. A beep will sound and “MAINTENANCE MODE” will display momentarily in the Information Window.
3. Release all keys. “SERIAL NO #####” will display in the Information Window.

### The following keys are available in MAINTENANCE MODE:



#### Incline Keys

**Increase and Decrease LEVEL Keys:** Adjust the value of the displayed parameter up and down, respectively, in increments of 1 unit. These keys do not save the new value.



#### Numeric Keypad

**Numeric Keypad:** Allows you to enter specific values for numeric parameters. These keys do not save the new value.



#### OK Key

Updates (saves) the values of all parameters in non-volatile memory, and exits Maintenance Mode.

**NOTE:** To exit Maintenance Mode without saving any values or settings, press the QUICK START key.

### A complete list of the items that you may display and change in Maintenance Mode:

Item	Lowest Value	Highest Value	Default	Notes
<b>Vx.xx Sum</b>	N/A	N/A	V958 6C92FBD4	
<b>Update software</b>	N/A	N/A		Update console software via USB
<b>contrast</b>	0	100	100	Display contrast setting
<b>backlight</b>	10	200	200	Display backlight setting
<b>WD</b>	N/A	N/A	on/off	
<b>pd time</b>	N/A	N/A	on/off	Person Detect
<b>Burn in mode</b>			N/A	(Manufacture Only)
<b>Elev Calibration</b>				Elevation calibration function
<b>motor calibration</b>				Motor calibration function
<b>cal values</b>				Resets Console to default factory settings
<b>error list</b>				List of last errors
<b>error stats</b>	N/A	N/A		Count of errors
<b>serial # port tests</b>	N/A	N/A		Access to Serial Port Test function
<b>heartrate test</b>	N/A	N/A		Access to Heart Rate System Test function
<b>keypad test</b>	N/A	N/A		Access to Keypad Test function



Item	Lowest Value	Highest Value	Default	Notes
<b>display test</b>	N/A	N/A		Access to LCD Test function
<b>program stats</b>	N/A	N/A		Access to program usage counts
<b>last belt</b>	0	65,535	0	Number of miles since belt was last replaced
<b>last deck</b>	0	65,535	0	Number of miles since deck was last replaced
<b>model</b>	N/A	N/A	1 or 2	Choose Model 1 for 8-TR, Model 2 for 8-TRx
<b>deccel time</b>	8	60	25	
<b>accel time</b>	8	60	30	
<b>max speed</b>	5.0/5.0	15.0/24.0 (12.5/20.0 for 8-TR)	12.5/20	Max speed (MPH/KPH)
<b>min speed</b>	0.5/0.8	2.0/3.2	0.5/0.8	Min speed (MPH/KPH)
<b>lockout ID</b>	1	999	999	Treadmill lockout ID
<b>Lockout EN</b>	-	-	OFF	Enable or disable treadmill lockout
<b>Csafe</b>	-	-	OFF	Turns CSAFE function ON or OFF
<b>Elevation</b>	-	-	ON	Enable/Disable Elevation function
<b>Ant +</b>	-	-	OFF	Turns ANT PLUS function ON or OFF
<b>Auto fan</b>	-	-	ON	Turns AUTO FAN function ON or OFF
<b>Pause time</b>	30	120	45	Pause duration, in seconds, during a program
<b>Mets</b>	-	-	OFF	Enable/Disable METS display
<b>Lang</b>	-	-	English	Language is English (ENGL), German (GERM), Spanish (SPAN), Dutch (DUCT), Portuguess (PORT), French (FREN), Italian (ITAL), Swedish(SWED), Katakana (KATA) or Russian (RUS).
<b>Weight</b>	50	500/226	155/70	Default user weight used in calorie calculations if not entered by user (lbs/kg)
<b>Max time</b>	5	99	99	Max workout time allowed
<b>units</b>	-	-	English	English = pounds, feet; Metric = kilograms, meters
<b>distance</b>	0	65,535	0	Total distance (miles) since last reset
<b>Op hours</b>	0	65,535	0	Total operating hours since last reset
<b>serial #</b>	-	-		

### MAINTENANCE MODE - TOUCHSCREEN

To enter maintenance mode on a 15"-19" EC touchscreen display, in sequence press the top left corner, then top right, then top left again. To enter maintenance mode on 15" touchscreen display, simultaneously press the Vol UP, Channel UP and the number 3 on the media center keypad. To enter maintenance mode on the 10" touchscreen display, in sequence press the top left corner, then top right corner, then the Logo.

The maintenance menus for the touchscreen displays contain many of the same options as for the LCD displays, as well as a few extra options related directly to touchscreens, such as touchscreen calibration and an option to upload background images. Refer to the touchscreen manual for more information.



## CALIBRATION - OPENHUB LCD

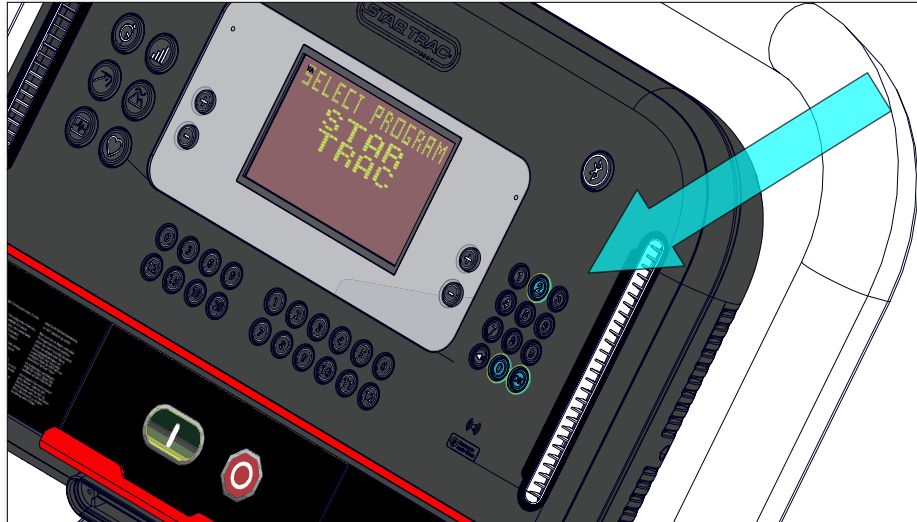

Fig. 17 Accessing the Service Menu

### Speed Calibration Procedure

1. On the numeric keypad, press and hold the **0**, **2** and **OK** keys together. The Service Menu will display.
2. A beep will sound and “MAINTENANCE MODE” will display momentarily in the Information Window.
3. Release all keys. “SERIAL NO #####” will display in the Information Window.
4. Use the incline keys to navigate.
5. Navigate to **Motor Calibration**
6. Tap the **OK** key to begin elevation calibration.

**⚠ WARNING:** Do not stand on moving surface during calibration.

### Elevation Calibration Procedure

1. On the numeric keypad, press and hold the **0**, **2** and **OK** keys together. The Service Menu will display.
2. A beep will sound and “MAINTENANCE MODE” will display momentarily in the Information Window.
3. Release all keys. “SERIAL NO #####” will display in the Information Window.
4. Use the incline keys to navigate.
5. Navigate to **Elev Calibration**
6. Tap the **OK** key to begin elevation calibration.

**⚠ WARNING:** Do not stand on moving surface during calibration.

## CALIBRATION - OPENHUB TOUCHSCREEN

### Speed Calibration Procedure

1. On the top of the touchscreen, tap the upper left corner, then upper right, then upper left again. Password Screen will display.
2. Enter password **214** then tap **OK**. Service Menu will display.



Fig. 18

3. Tap Calibration and Setup

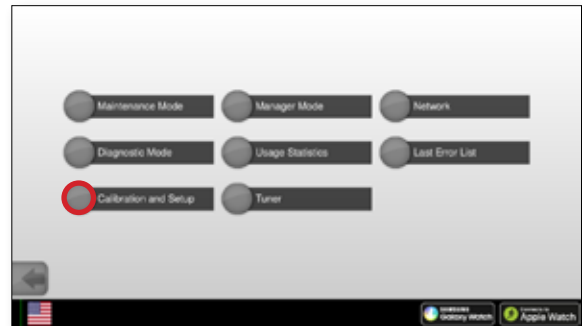

Fig. 19

4. Tap Speed Calibration on the Calibration and Setup screen.



Fig. 20

5. Press START to begin the calibration.
  - ⚠ WARNING:** Do not stand on moving surface during calibration.
6. After the Speed Calibration is completed, press EXIT; The Calibration And Setup screen appears.
7. Press to exit and go back to the Home Screen.
8. The Speed Calibration has been completed.



Fig. 21

### Incline Calibration Procedure

1. On the top of the touchscreen, tap the upper left corner, then upper right, then upper left again. Password Screen will display.
2. Enter password **214** then tap **OK**. Service Menu will display.



Fig. 22

3. Tap Calibration and Setup

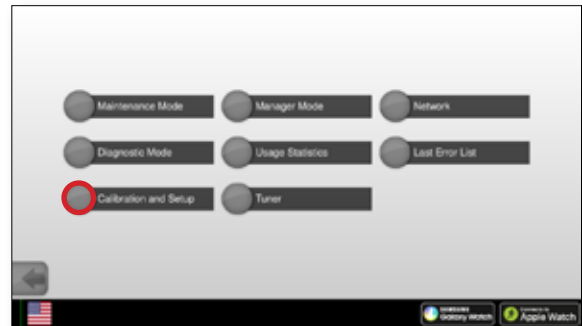

Fig. 23

4. Tap Speed Calibration on the Calibration and Setup screen.



Fig. 24

5. Press START to begin the calibration.
  - ⚠ **WARNING:** Do not stand on moving surface during calibration.
6. After the Incline Calibration is completed, press EXIT; The Calibration And Setup screen appears.
7. Press to exit and go back to the Home Screen.
8. The Incline Calibration has been completed.



Fig. 25

## TOOLS

Working on this product will require basic and/or sometimes specialty tools based on the type of service that will be performed at any time. To assist, we recommend having the tools listed available when performing maintenance.

Tool	
Multi-meter	Screwdriver Set, Phillips
Socket Set, SAE	Screwdriver Set, Flat
Socket Set, Metric	Tape Measure
Socket driver	Ball-Peen Hammer
Open end wrenches, SAE	Rubber Mallet
Open end wrenches, Metric	USB - Flash Drive
Hex Bit Socket Set, SAE	Motorcycle straps, adjustable
Hex Bit Socket Set, Metric	Loctite 680
Adjustable Wrench	1' Jumper wire w/ alligator clips
Snap Ring Pliers	zip ties – various sizes
Torque Wrench	



**SCAN TO WATCH A BRIEF  
MAINTENANCE VIDEO  
ON STARTRAC TREADMILLS**

**IMPORTANT NOTE:** Do not use power tools on fasteners, it will damage the plastic shrouds.

## MAINTENANCE SCHEDULE

The safety and integrity of this machine can only be maintained when the equipment is regularly examined for damage and wear and repaired. It is the sole responsibility of the owner of this equipment to ensure that regular maintenance is performed. Worn or damaged parts must be replaced immediately or the equipment removed from service until the repair is made.

Some types of PM need to be performed more often than others. The frequency of PM depends a great deal on the use and environment of the unit. Basic scheduling is shown below, but timeline and PM schedules should be adapted to the environment and usage that the unit receives. Refer to the OpenHub Manual for further maintenance information on the console.

Maintenance Schedule	Daily	Weekly	Monthly	Every 6 Months	Yearly
<b>Cleaning</b>					
Wipe down all surfaces	X				
Wipe Moving Surface <sup>1</sup> with dry cloth <sup>2</sup>	X				
Clean Console <sup>3</sup>	X				
Elevate unit and vacuum underneath		X			
Unplug unit and vacuum underneath motor shroud				X	
<b>General Maintenance</b>					
Check tracking to assure moving surface stays centered		X			
Check Condition of Power Cord <sup>4</sup>			X		
Inspect and Clean underside of moving surface <sup>5</sup>			X		
Check drive belt tension			X		
Check moving surface tension, adjusting if needed			X		
Check all settings and Keypad Performance			X		
Calibrate Elevation & Speed				X	

1 Earlier documentation may refer to the moving surface as the 'running belt'.

2 To ensure the longevity of the moving surface, clean under the moving surface with a soft, dry cloth. To clean, slide the cloth between the moving surface and deck from one side of the frame to the other (you may need a ruler or similar tool to slide the towel under the belt), then, holding the edges of the cloth, pull the cloth from the headroller down to the tailroller.

3 Wipe console with a soft, non-abrasive cloth to remove all sweat after each use. Use a soft, non-abrasive cloth and mild spray cleanser to clean the console. Never use abrasive cleaning liquids, cleaning liquids with an oil base, ammonia, or alcohol.

4 Ensure the power cord is not under the treadmill and is positioned away from the elevation screws. This will prevent the power cord from being pinched or from binding up the elevation screws.

5 Inspect the inside surface of the moving surface and the top surface of the running deck for unusual wear. Check the belt for a "glazed" condition (a smooth almost melted appearance). If the moving surface appears glazed, replace the moving surface and flip or replace the running deck.

**NOTE:** Never install a new moving surface on a used deck.

Maintenance Schedule	Daily	Weekly	Monthly	Every 6 Months	Yearly
Check Moving Surface and Deck Condition and replace if wear found				X	
Unplug unit and check all power connections including speed sensor				X	

### Preventive Maintenance Cautions

- While maintaining equipment you will want to avoid spraying any liquids directly onto any surface of the unit. Always spray cleaning solutions onto a clean towel first then wipe the unit.
- Do not use glass cleaners or any other household cleaners on the console. The console should be cleaned with a damp cloth and dried on a daily basis. Cleaning solutions can be made of a 5:1 dilution ratio, where 5 parts water are mixed with 1 part of Simple Green®, Fantastik®, or 409®. Do not spray water, or cleaner directly onto console USB Port. Do not use liquid cleaner under the moving surface.
- **⚠ WARNING:** Do not clean the moving surface by activating the treadmill.

### INSPECTION

Inspect the frame for any rust, bubbling, or paint chips during the daily cleaning. The salt in perspiration can damage the unpainted surfaces. Repair the damaged area with a touch-up paint kit purchased from Core Health & Fitness (call Customer Service for order information).

**NOTE:** To prevent potential damage to the IEC connector when moving the machine, we recommend that you elevate the treadmill to 5%+ grade before moving.

For Technical Support, Service, Parts Orders or any Customer Service needs, please contact us direct by phone, email, or through our 24 hour support site:

**GLOBAL SUPPORT CENTER**  
4400 NE 77th Avenue, Suite 300 Vancouver, WA 98662  
Tel: (360) 326-4090 • (888) 678-2476 • [support@corehandf.com](mailto:support@corehandf.com)

Warranty information: <https://corehandf.com/warranty>

To help us support you, please provide the following information when requesting assistance with your equipment:

■ Facility Name & Address      ■ Product Serial Number      ■ Description of Issue

Our goal is to provide fast, reliable support to all your product support requests. We strive to answer all support requests under an average hold time of 3 minutes, all support emails within 1 business day and all field service requests within 48 hours.

## PREVENTATIVE MAINTENANCE

Protect your product & assure it always runs like new with a Core Advantage Preventative Maintenance or Extended Warranty Package. Contact your service manager for more information: [servicecontracts@corehandf.com](mailto:servicecontracts@corehandf.com)

# CORE CONNECT

Core Connect is your portal to all things service! Whether you need to order parts or register your warranty, Core Connect is the most effective way to get what you need fast and keep your facility operating smoothly.

## OFFERS 24-HOUR SELF SERVICE ACCESS TO:

- General Inquiries
- Warranty Registration
- Preventative Maintenance
- Service Requests
- Parts Orders
- Automated partner payment
- Product technical library
- Transparency on service performance
- Real time communication



To request access visit:  
**SUPPORT.COREHANDF.COM**

